



ASTRO® APX™ O5 Control Head Mobile Radio Quick Reference Card

Product Safety and RF Exposure Compliance



Before using this product, read the operating instructions for safe usage contained in the Product Safety and RF Exposure booklet enclosed with your radio.

ATTENTION!

This radio is restricted to occupational use only to satisfy FCC RF energy exposure requirements. Before using this product, read the RF energy awareness information and operating instructions in the Product Safety and RF Exposure booklet enclosed with your radio (Motorola Publication part number 6881095C99) to ensure compliance with RF energy exposure limits.

Radio Controls

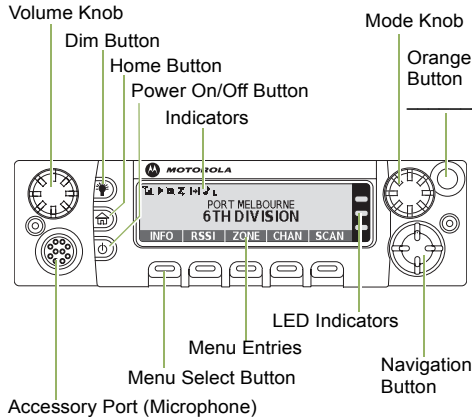

Radio On/Off

Press the Power On/Off button to toggle the power on or off.

Adjusting Volume

Turn the Volume Knob clockwise to increase volume or counterclockwise to decrease the volume.

Selecting a Zone

- 1 **▶** or **◀** to **ZONE**.
- 2 **▶** or **◀** button until the desired zone is displayed.
- 3 Press **⬆** or the **PTT** button to confirm the selected zone number.
- 4 Press the **PTT** button to begin transmitting on the displayed zone channel.

Selecting a Channel

- 1 Press and hold **▶** to scroll to **CHAN** and press the **Menu Select** button directly below **CHAN**. The display shows the current zone and channel.
- 2 Rotate the **Mode** knob to the desired channel.
- 3 Press **⬆** or the **PTT** button to confirm the channel.
- 4 Press the **PTT** button to transmit on the displayed zone channel.

Receiving and Transmitting

- 1 Take the microphone off hook.
- 2 Select zone/channel.
- 3 Listen for a transmission.
OR
Turn the **Volume** Knob.
OR
▶ or **◀** to **MON** then press the **Menu Select** button directly below **MON** and listen for activity.
- 4 Adjust volume, if necessary.
- 5 Press the **PTT** button to transmit; release to receive.

Sending an Emergency Alarm

- 1 Press the **Emergency** button. A tone sounds and the display alternates **EMERGENCY** and the home display.
- 2 A dispatcher acknowledgment **ACK RECEIVED** display follows.
AND, Trunking Only:
A high-pitched tone indicates that the alarm has been received by the trunked system's central controller.
- 3 Press and hold the emergency button or the **PTT** button to return to normal operation.

*To exit emergency at any time, press and hold the **Emergency** button.*

MOTOROLA, MOTO, MOTOROLA SOLUTIONS and the Stylized M logo are trademarks or registered trademarks of Motorola Trademark Holdings, LLC and are used under license. All other trademarks are the property of their respective owners.
© 2009–2011 by Motorola Solutions, Inc. All Rights Reserved. 06/11
1303 East Algonquin Road, Schaumburg, Illinois 60196, U.S.A.



PMLN5592D

English

Sending an Emergency Call (Trunking Only)

- 1 Press Emergency button.
- 2 A tone sounds and the display alternates **EMERGENCY** and the home display.
OR
A talk prohibited tone sounds when the selected channel does not support emergency.
- 3 Press and hold the **PTT** button. Speak clearly into the microphone.
- 4 Release the **PTT** to end the transmission.





*To exit emergency at any time, press and hold the **Emergency** button.*







Sending a Silent Emergency Alarm







- 1 Press the preprogrammed **Emergency** button to activate the silent alarm feature.
- 2 The display does not change; the LED does not light up, and there is no tone.

*If silent emergency alarm is used with emergency call, pressing the **PTT** button exits the silent mode and initiates the emergency call.*

Display Status Icons

	Receiving a call or data.
	Transmitting a call or data.
	Received an Individual Call.
	The more stripes, the stronger the signal strength for the current site (trunking only).

	Direct radio-to-radio communication or communication through a repeater. On = Direct Off = Repeater
	This channel is being monitored.
	Voice muting the affiliated trunking talkgroup or selected conventional channel. On = Enabled Off = Disabled
	L = Radio is set at Low power. H = Radio is set at High power.
	Scanning a scan list.
	Blinking dot = Detects activity on the Priority-One Channel during scan. Steady dot = Detects activity on the Priority-Two Channel during scan.
	Radio is in the view or program mode. On steady = View mode. Blinking = Program mode.

	The vote scan feature is enabled.
	On = Secure operation. Off = Clear operation. Blinking = Receiving an encrypted voice call.
	On = AES Secure operation. Off = Clear operation. Blinking = Receiving an encrypted voice call.
	On = Location feature enabled, and location signal available. Off = Location feature disabled. Blinking = Location feature enabled, but location signal unavailable.
	On = User is currently associated with the radio. Off = User is currently not associated with the radio. Blinking = Device registration or user registration with the server failed due to an invalid username or pin.
	Data activity is present.

Menu Navigation

